

Light Right-Hand Rule

Light is a transverse electromagnetic wave. The electric **E** and magnetic **M** fields are perpendicular to each other and to the propagation vector **k**, as shown below.

Power density is given by Poynting's vector, **P**, the vector product of **E** and **H**. You can easily remember the directions if you "curl" **E** into **H** with the fingers of the right hand: your thumb points in the direction of propagation.

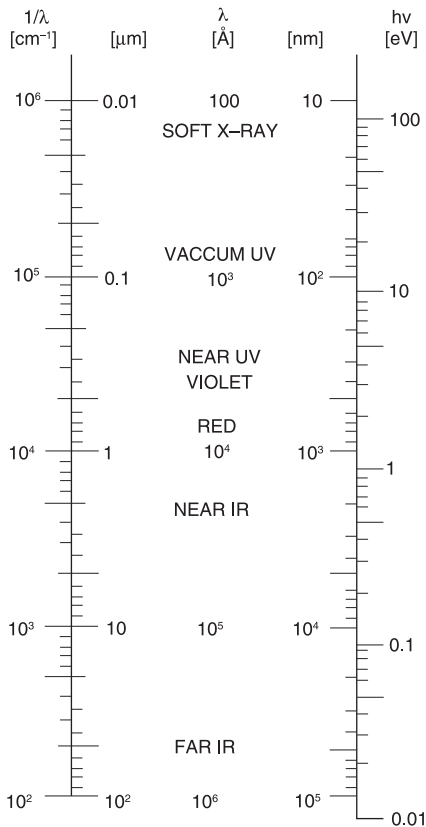
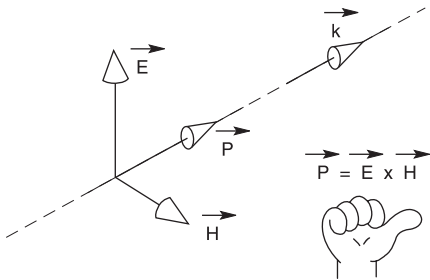

Optics Formulas

Light Intensity

The light intensity, *I* is measured in Watts/m², *E* in Volts/m, and *H* in Amperes/m. The equations relating *I* to *E* and *H* are quite analogous to OHMS LAW. For peak values these equations are:

$$E = \eta H, \quad H = \frac{E}{\eta}, \quad \eta = \frac{E}{H}$$

$$I = \frac{EH}{2}, \quad I = \frac{E^2}{2\eta}, \quad I = \frac{\eta H^2}{2}$$

$$E = \sqrt{2\eta I}, \quad H = \sqrt{\frac{2I}{\eta}}$$

$$\eta_0 = 377 \text{ ohms } (\Omega)$$

$$\eta = \frac{\eta_0}{n}$$

The quantity η_0 is the wave impedance of vacuum, and η is the wave impedance of a medium with refractive index *n*.

Wave Quantity Relationship

$$k = \frac{2\pi}{\lambda} = \frac{2\pi n}{\lambda_0}$$

$$= \frac{2\pi n\nu}{c} = \frac{n\omega}{c}$$

$$\nu = \frac{c}{\lambda_0} = \frac{c}{n\lambda}$$

$$= \frac{kc}{2\pi n} = \frac{\omega}{2\pi}$$

$$\lambda = \frac{c}{n\nu} = \frac{\lambda_0}{n}$$

$$= \frac{2\pi}{k} = \frac{2\pi c}{n\omega}$$

- k*: wave vector [radians/m]
- ν : frequency [Hertz]
- ω : angular frequency [radians/sec]
- λ : wavelength [m]
- λ_0 : wavelength in vacuum [m]
- n*: refractive index

Energy Conversions

$$\text{Wave Number } (\nu) [\text{cm}^{-1}]$$

$$= \frac{10^4}{\lambda_0 [\mu\text{m}]}$$

$$\text{Electron volts (eV) per photon}$$

$$= \frac{1.242}{\lambda_0 [\mu\text{m}]}$$

Wavelength Conversions

$$1 \text{ nm} = 10 \text{ Angstroms}(\text{Å})$$

$$= 10^{-9}\text{m} = 10^{-7}\text{cm} = 10^{-3}\mu\text{m}$$

Snell's Law

Snell's Law describes how a light ray behaves when it passes from a medium with index of refraction *n*₁, to a medium with a different index of refraction, *n*₂. In general, the light will enter the interface between the two media at an angle. This angle is called the angle of incidence. It is the angle measured between the normal to the surface (interface) and the incoming light beam (see figure). In the case that *n*₁ is smaller than *n*₂, the light is bent towards the normal. If *n*₁ is greater than *n*₂, the light is bent away from the normal (see figure below). Snell's Law is expressed as *n*₁sin θ ₁ = *n*₂sin θ ₂.

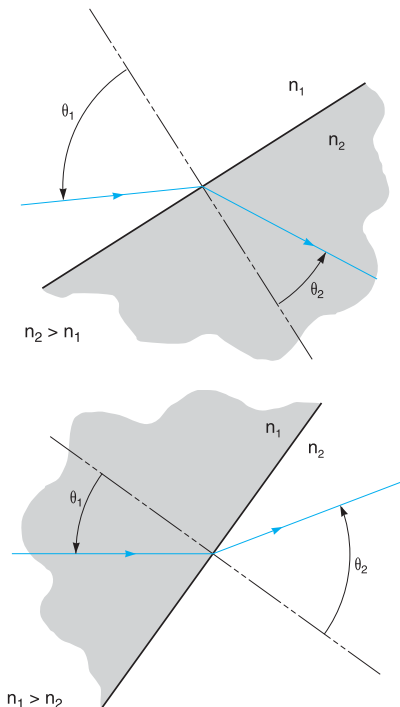

Plane-Polarized Light

For plane-polarized light the **E** and **H** fields remain in perpendicular planes parallel to the propagation vector **k**, as shown below.

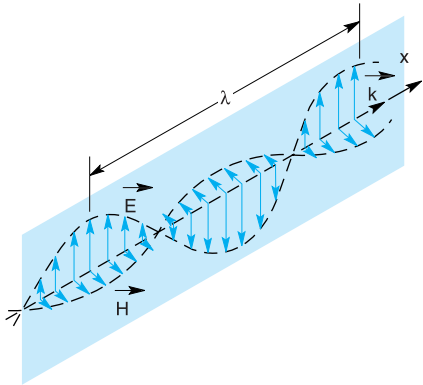

Both **E** and **H** oscillate in time and space as:

$$\sin(\omega t - kx)$$

Beam Displacement

A flat piece of glass can be used to displace a light ray laterally without changing its direction. The displacement varies with the angle of incidence; it is zero at normal incidence and equals the thickness *h* of the flat at grazing incidence.

(Grazing incidence: light incident at almost or close to 90° to the normal of the surface).

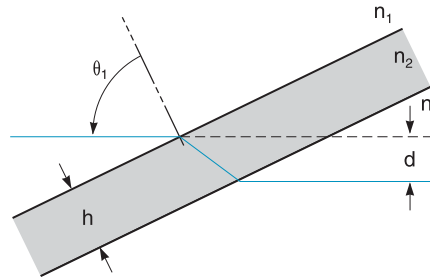

$$d = h \sin \theta_1 \left[1 - \frac{\cos \theta_1}{\sqrt{\left(\frac{n_2}{n_1}\right)^2 - \sin^2 \theta_1}} \right]$$

The relationship between the tilt angle of the flat and the two different refractive indices is shown in the graph below.

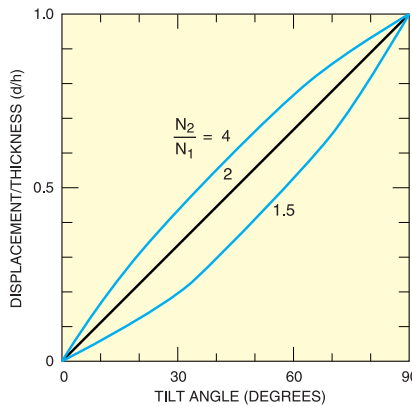

Beam Deviation

Both displacement and deviation occur if the media on the two sides of the tilted flat are different — for example, a tilted window in a fish tank. The displacement is the same, but the angular deviation δ is given by the formula. Note: δ is independent of the index of the flat; it is the same as if a single boundary existed between media 1 and 3.

Example: The refractive index of air at STP is about 1.0003. The deviation of a light ray passing through a glass Brewster's angle window on a HeNe laser is then:

$$\delta = (n_3 - n_1) \tan \theta$$

At Brewster's angle, $\tan \theta = n_2$

$$\delta = (0.0003) \times 1.5 = 0.45 \text{ mrad}$$

At 10,000 ft. altitude, air pressure is 2/3 that at sea level; the deviation is 0.30 mrad. This change may misalign the laser if its two windows are symmetrical rather than parallel.

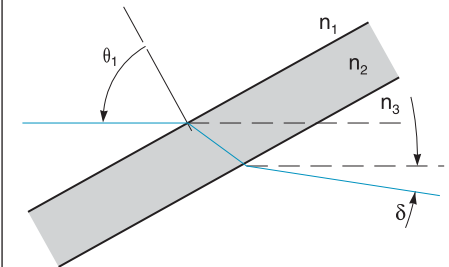

$$\delta = \theta_1 - \sin^{-1} \left(\frac{n_1}{n_3} \sin \theta_1 \right) \cong (n_3 - n_1) \tan \theta_1, \text{ if } n_3 \oplus n_1$$

Angular Deviation of a Prism

Angular deviation of a prism depends on the prism angle α , the refractive index, n , and the angle of incidence θ_i . Minimum deviation occurs when the ray within the prism is normal to the bisector of the prism angle. For small prism angles (optical wedges), the deviation is constant over a fairly wide range of angles around normal incidence. For such wedges the deviation is:

$$\delta \approx (n - 1)\alpha$$

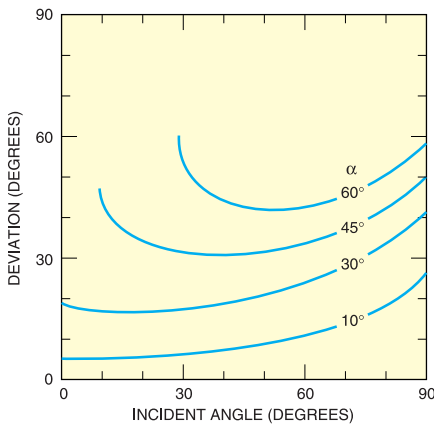
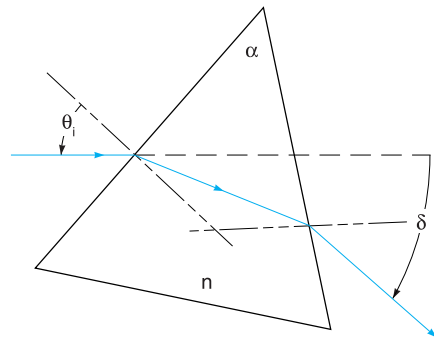

Prism Total Internal Reflection (TIR)

TIR depends on a clean glass-air interface. Reflective surfaces must be free of foreign materials. TIR may also be defeated by decreasing the incidence angle beyond a critical value. For a right angle prism of index n , rays should enter the prism face at an angle θ :

$$\theta < \arcsin(((n^2-1)^{1/2}-1)/\sqrt{2})$$

In the visible range, $\theta = 5.8^\circ$ for BK 7 ($n = 1.517$) and 2.6° for fused silica ($n = 1.46$). Finally, prisms increase the

optical path. Although effects are minimal in laser applications, focus shift and chromatic effects in divergent beams should be considered.

Fresnel Equations:

i - incident medium
 t - transmitted medium
 use Snell's law to find θ_t

Normal Incidence:

$$r = (n_i - n_t) / (n_i + n_t)$$

$$t = 2n_i / (n_i + n_t)$$

Brewster's Angle:

$$\theta_\beta = \arctan(n_t / n_i)$$

Only s-polarized light reflected.

Total Internal Reflection (TIR):

$$\theta_{TIR} > \arcsin(n_t / n_i)$$

$n_t < n_i$ is required for TIR

Field Reflection and Transmission Coefficients:

The field reflection and transmission coefficients are given by:

$$r = E_r / E_i \quad t = E_t / E_i$$

Non-Normal Incidence:

$$r_s = (n_i \cos \theta_i - n_t \cos \theta_t) / (n_i \cos \theta_i + n_t \cos \theta_t)$$

$$r_p = (n_t \cos \theta_i - n_i \cos \theta_t) / (n_t \cos \theta_i + n_i \cos \theta_t)$$

$$t_s = 2n_i \cos \theta_i / (n_i \cos \theta_i + n_t \cos \theta_t)$$

$$t_p = 2n_i \cos \theta_i / (n_t \cos \theta_i + n_i \cos \theta_t)$$

Power Reflection:

The power reflection and transmission coefficients are denoted by capital letters:

$$R = r^2 \quad T = t^2 (n_t \cos \theta_t) / (n_i \cos \theta_i)$$

The refractive indices account for the different light velocities in the two media; the cosine ratio corrects for the different cross sectional areas of the beams on the

two sides of the boundary.

The intensities (watts/area) must also be corrected by this geometric obliquity factor:

$$I_t = T \times I_i (\cos \theta_i / \cos \theta_t)$$

Conservation of Energy:

$$R + T = 1$$

This relation holds for p and s components individually and for total power.

Polarization

To simplify reflection and transmission calculations, the incident electric field is broken into two plane-polarized components. The "wheel" in the pictures below denotes plane of incidence. The normal to the surface and all propagation vectors ($\mathbf{k}_i, \mathbf{k}_r, \mathbf{k}_t$) lie in this plane.

\mathbf{E} parallel to the plane of incidence; p-polarized.

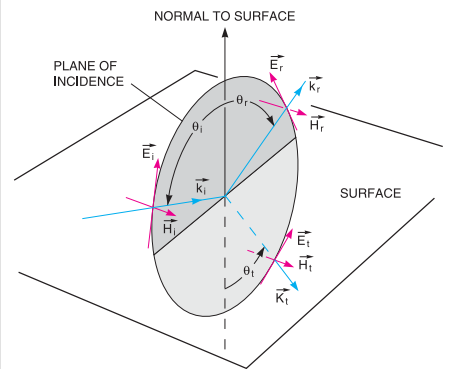

\mathbf{E} normal to the plane of incidence; s-polarized.

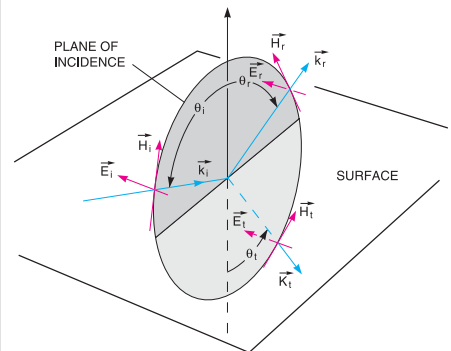

Power Reflection Coefficients

Power reflection coefficients R_s and R_p are plotted linearly and logarithmically for light traveling from air ($n_i = 1$) into BK 7 glass ($n_t = 1.51673$). Brewster's angle = 56.60° .

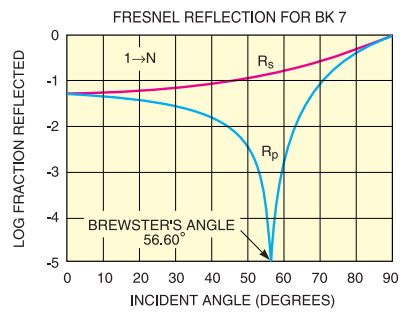
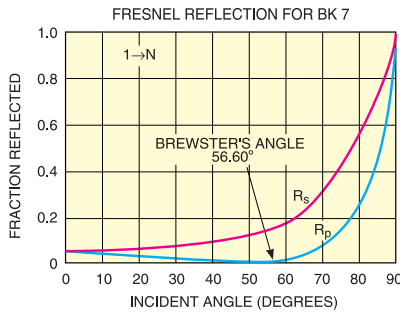

The corresponding reflection coefficients are shown below for light traveling from BK 7 glass into air Brewster's angle = 33.40° . Critical angle (TIR angle) = 41.25° .

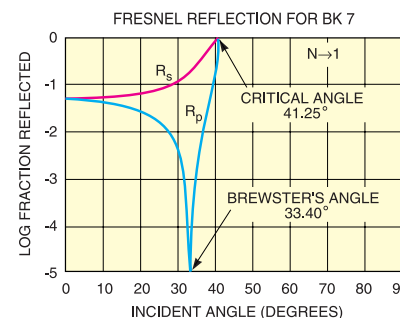
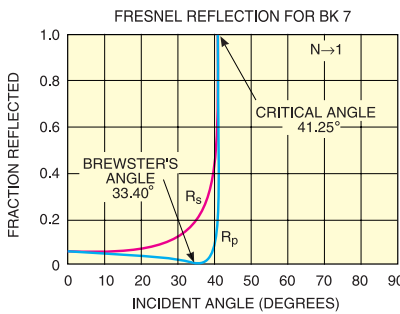

Thin Lens Equations

If a lens can be characterized by a single plane then the lens is "thin". Various relations hold among the quantities shown in the figure.

Gaussian:

$$\frac{1}{s_1} + \frac{1}{s_2} = \frac{1}{F}$$

Newtonian: $x_1 x_2 = -F^2$

Magnification:

Transverse:

$$M_T = \frac{y_2}{y_1} = -\frac{s_2}{s_1}$$

$M_T < 0$, image inverted

Longitudinal:

$$M_L = \frac{\Delta x_2}{\Delta x_1} = -M_T^2$$

$M_L < 0$, no front to back inversion

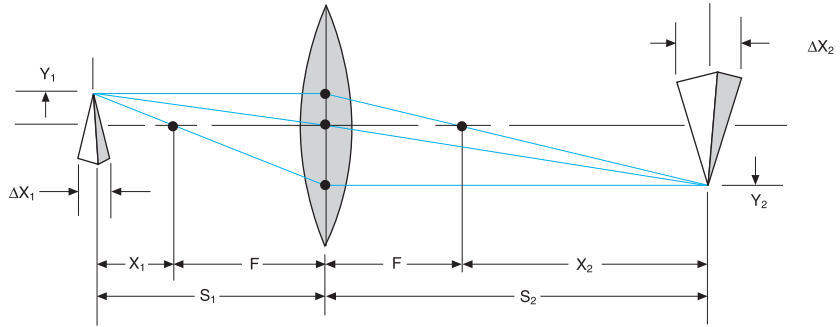

Sign Conventions for Images and Lenses

Quantity	+	-
s_1	real	virtual
s_2	real	virtual
F	convex lens	concave lens

Thick Lenses

A thick lens cannot be characterized by a single focal length measured from a single plane. A single focal length F may be retained if it is measured from two planes, H_1, H_2 , at distances P_1, P_2 from the vertices, V_1, V_2 . The two back focal lengths, BFL_1 and BFL_2 , are measured from the vertices. The thin lens equations may be used, provided all quantities are measured from the principal planes.

Lens Types for Minimum Aberration

$ s_2/s_1 $	Best lens
< 0.2	plano-convex/concave
> 5	plano-convex/concave
> 0.2 or < 5	bi-convex/concave

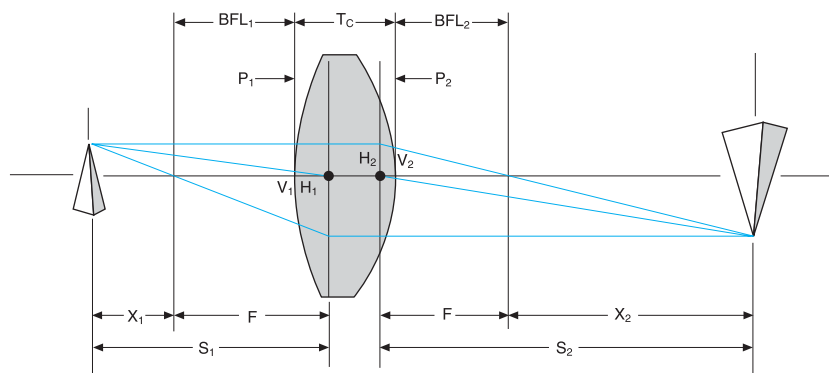

Lens Nomogram:

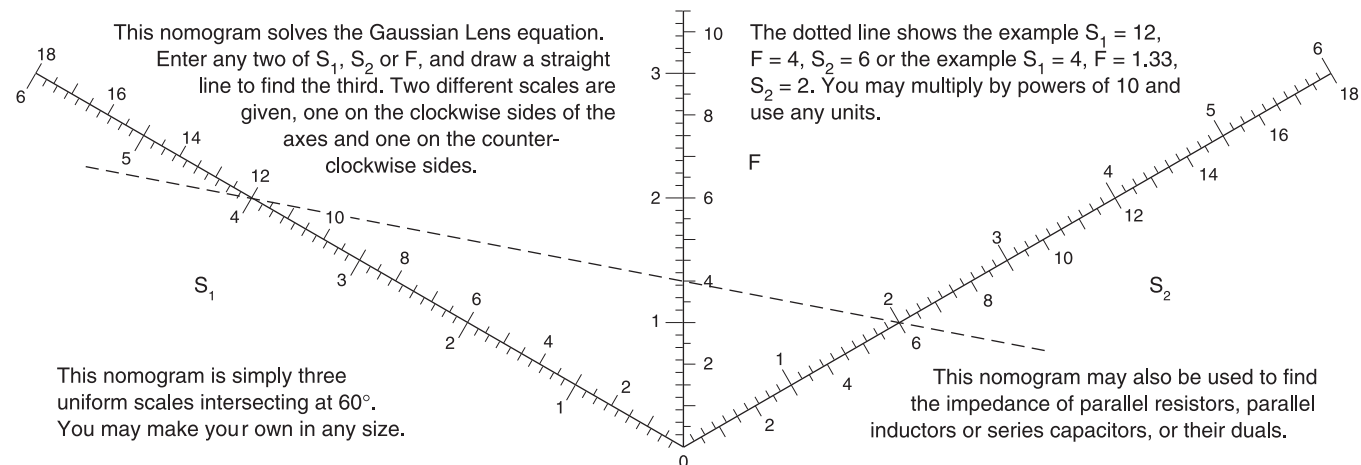

The Lensmaker's Equation

Convex surfaces facing left have positive radii. Below, $R_1 > 0$, $R_2 < 0$. Principal plane offsets, P , are positive to the right. As illustrated, $P_1 > 0$, $P_2 < 0$. The thin lens focal length is given when $T_c = 0$.

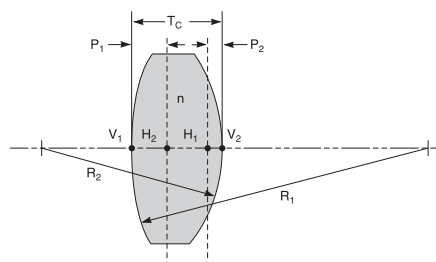

$$\frac{1}{F} = (n-1) \left[\frac{1}{R_1} - \frac{1}{R_2} + \frac{(n-1)T_c}{nR_1R_2} \right]$$

$$P_1 = -\frac{F(n-1)T_c}{nR_2}$$

$$P_2 = -\frac{F(n-1)T_c}{nR_1}$$

Numerical Aperture

ϕ_{MAX} is the full angle of the cone of light rays that can pass through the system (below).

$$NA = n_0 \sin\left(\frac{\phi_{MAX}}{2}\right)$$

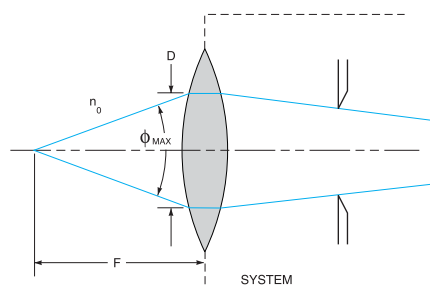

For small ϕ :

$$f/\# = \frac{F}{D} \approx \frac{1}{2 NA}$$

Both f-number and NA refer to the system and not the exit lens.

Constants and Prefixes

Speed of light in vacuum	$c = 2.99810^8$ m/s
Planck's const.	$h = 6.625 \times 10^{-34}$ Js
Boltzmann's const.	$k = 1.308 \times 10^{-23}$ J/K
Stefan-Boltzmann	$\sigma = 5.67 \times 10^{-8}$ W/m ² K ⁴
1 electron volt	$eV = 1.602 \times 10^{-19}$ J
exa (E)	10^{18}
peta (P)	10^{15}
tera (T)	10^{12}
giga (G)	10^9
mega (M)	10^6
kilo (k)	10^3
milli (m)	10^{-3}
micro (μ)	10^{-6}
nano (n)	10^{-9}
pico (p)	10^{-12}
femto (f)	10^{-15}
atto (a)	10^{-18}

Wavelengths of Common Lasers

Source	(nm)
ArF	193
KrF	248
Nd:YAG(4)	266
XeCl	308
HeCd	325, 441.6
N ₂	337.1, 427
XeF	351
Nd:YAG(3)	354.7
Ar	488, 514.5, 351.1, 363.8
Cu	510.6, 578.2
Nd:YAG(2)	532
HeNe	632.8, 543.5, 594.1, 611.9, 1153, 1523
Kr	647.1, 676.4
Ruby	694.3
Nd:Glass	1060
Nd:YAG	1064, 1319
Ho:YAG	2100
Er:YAG	2940

Gaussian Intensity Distribution

The Gaussian intensity distribution:

$$I(r) = I(0) \exp(-2r^2/\omega_0^2)$$

is shown below.

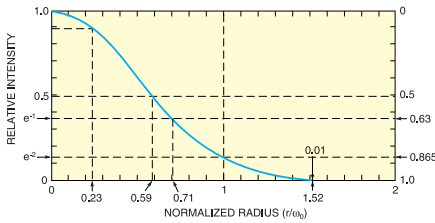

The right hand ordinate gives the fraction of the total power encircled at radius r:

$$P(r) = P(\infty) \left[1 - \exp(-2r^2/\omega_0^2) \right]$$

The total beam power, P(∞) [watts], and the on-axis intensity I(0) [watts/area] are related by:

$$P(\infty) = (\pi\omega_0^2/2) I(0)$$

$$I(0) = (2/\pi\omega_0^2) P(\infty)$$

Diffraction

The figure below compares the far-field intensity distributions of a uniformly illuminated slit, a circular hole, and Gaussian distributions with 1/e² diameters of D and 0.66D (99% of a 0.66D Gaussian will pass through an aperture of diameter D). The point of observation is Y off axis at a distance X>Y from the source.

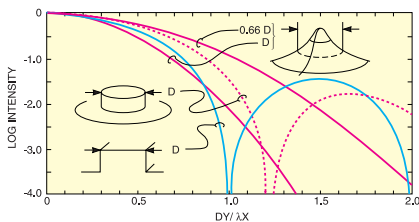

Focusing a Collimated Gaussian Beam

In the figure below the 1/e² radius, ω(x), and the wavefront curvature, R(x), change with x through a beam waist at x = 0. The governing equations are:

$$\omega^2(x) = \omega_0^2 \left[1 + \left(\lambda x / \pi \omega_0^2 \right)^2 \right]$$

$$R(x) = x \left[1 + \left(\pi \omega_0^2 / \lambda x \right)^2 \right]$$

2ω₀ is the waist diameter at the 1/e² intensity points. The wavefronts are planar at the waist [R(0) = ∞].

At the waist, the distance from the lens will be approximately the focal length: s₂ ≈ F.

D = collimated beam diameter or diameter illuminated on lens.

$$f\text{-number} \equiv f/\# = \frac{F}{D}$$

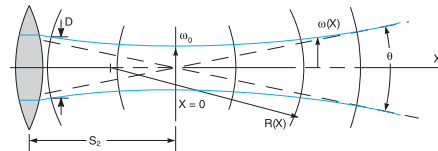

Depth of Focus (DOF)

$$DOF = (8\lambda/\pi)(f/\#)^2$$

Only if DOF < F, then:

New Waist Diameter

$$2\omega_0 = \left(\frac{4\lambda}{\pi} \right) (f/\#) = \left(\frac{4\lambda}{\pi} \right) \left(\frac{F}{D} \right)$$

Beam Spread

$$\theta = (f/\#)^{-1}$$